

Toroidal Suppression Core (2644801102)

Part Number: 2644801102

44 Toroidal Suppression Core

Explanation of Part Numbers:

- Digits 1 & 2 = Product Class
- Digits 3 & 4 = Material Grade
- Last digit 2 = Burnished (All cable cores have been burnished to remove the sharp edges)

Fair-Rite offers a broad selection of ferrite EMI suppression cable cores in several materials with guaranteed minimum impedance specifications.

For smaller suppression parts, refer to the section EMI Suppression Beads.

Our Expanded Cable and Suppressor Kit (part number 0199000005) contains a selection of these suppression cores.

For any cable suppression core not listed here, feel free to contact our customer service group for availability and pricing.

The C dimension may be modified to suit specific applications.

Weight: 2.4 (g)

Dim	mm	mm tol	nominal inch	inch misc.
A	12.7	±0.25	0.5	—
B	7.9	±0.20	0.311	—
C	6.35	±0.25	0.25	—

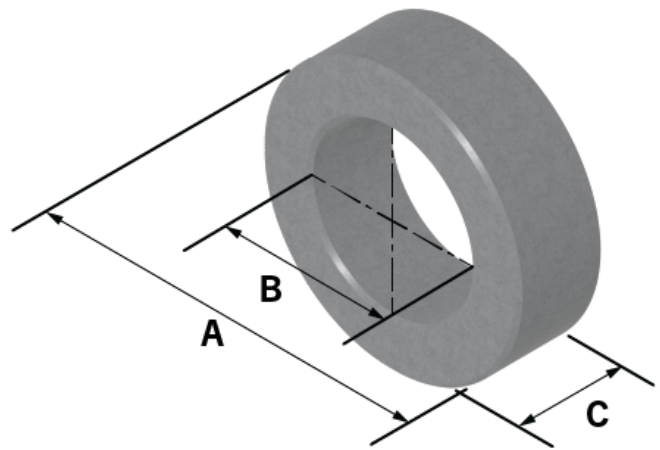

Chart Legend

$\Sigma l/A$: Core Constant, l_e : Effective Path Length, A_e : Effective Cross-Sectional Area, V_e : Effective Core Volume

A_L : Inductance Factor

Electrical Properties	
$A_e(\text{cm}^2)$	0.15
$l_e(\text{cm})$	3.12
$V_e(\text{cm}^3)$	0.47

Fair-Rite Products Corp. • One Commercial Row, Wallkill, New York 12589-0288
 888-324-7748 • 845-895-2055 • Fax: 845-895-2629 • ferrites@fair-rite.com • www.fair-rite.com